

Quick Installation Guide

NEED TECH HELP?

-  www.cudy.com/qr_vg_wr
 -  www.cudy.com
 -  support@cudy.com
 -  www.cudy.com/download
- 810600274

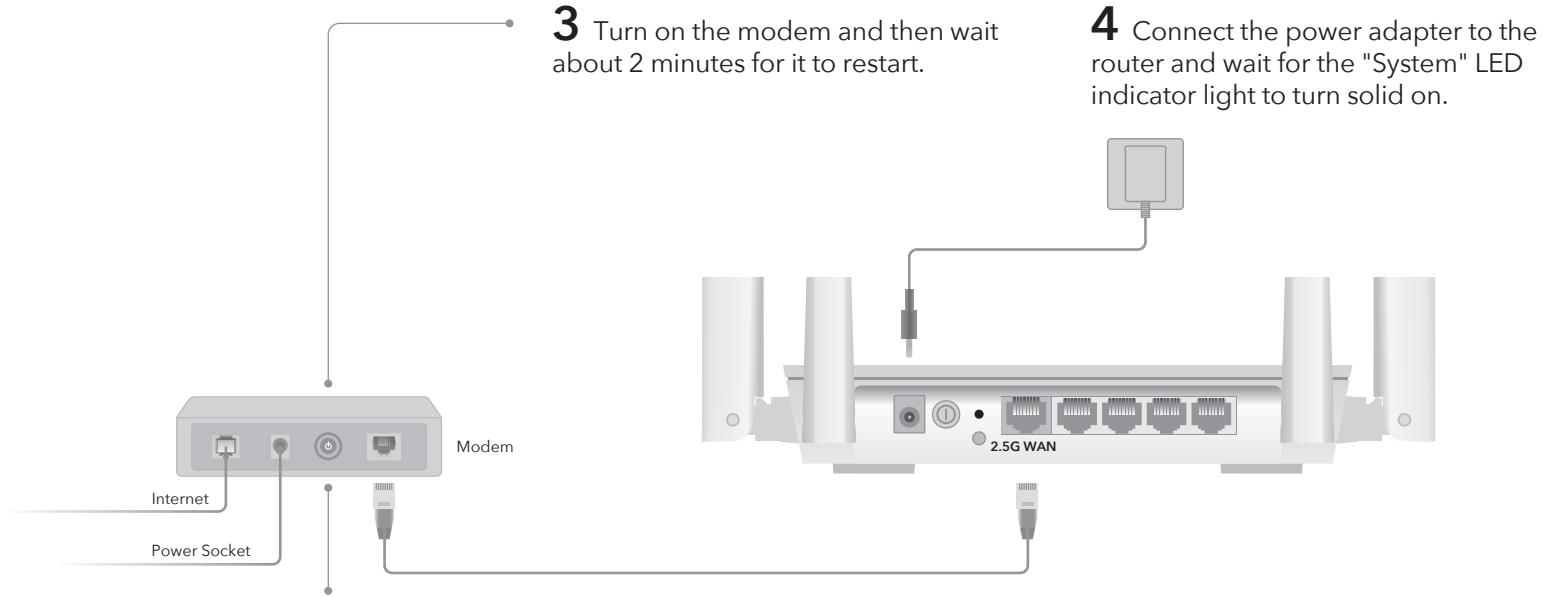

3 Turn on the modem and then wait about 2 minutes for it to restart.

4 Connect the power adapter to the router and wait for the "System" LED indicator light to turn solid on.

1 Turn off the modem, and remove the battery if it has one.

2 Connect Cudy's **WAN** port to your ISP modem.

5 Connect the router via **A** or **B** method.

A Wi-Fi: Connect your device to the router's Wi-Fi using the SSID (network name) and Password printed on the bottom of the router.

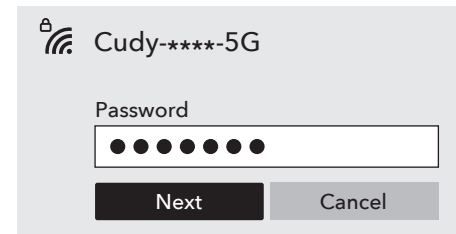
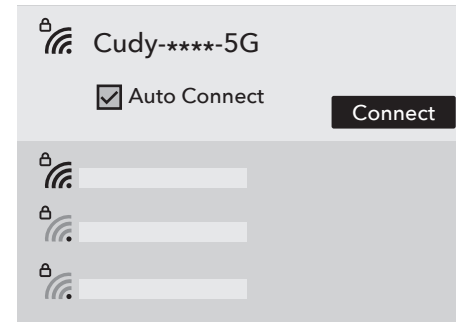
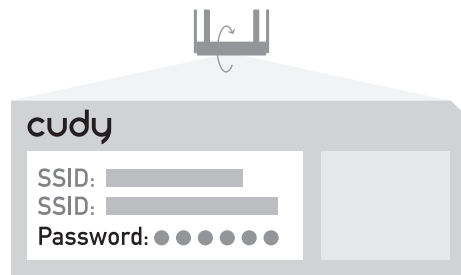

Go to step 6 and continue.

B Wired: Turn off the Wi-Fi on your computer and connect it to the router's **LAN** port via an Ethernet cable.

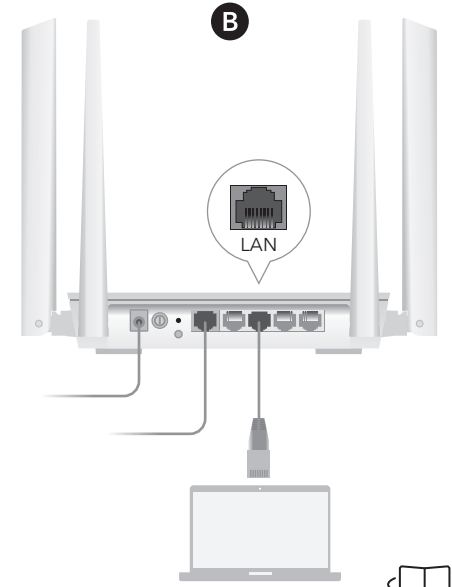

6 Launch a web browser, and enter <http://cudy.net/> or <http://192.168.10.1/> in the address bar. Create an administrator password to log in.

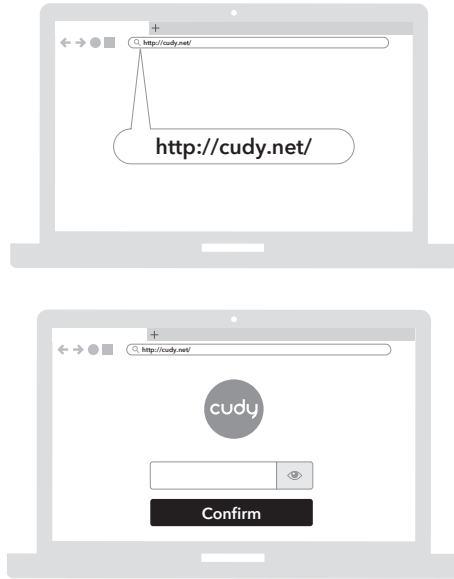
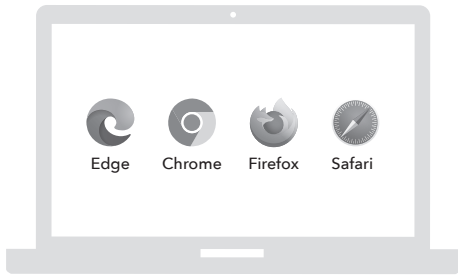

7 Then window below will pop up, please follow the step-by-step instructions to set up the internet connection.

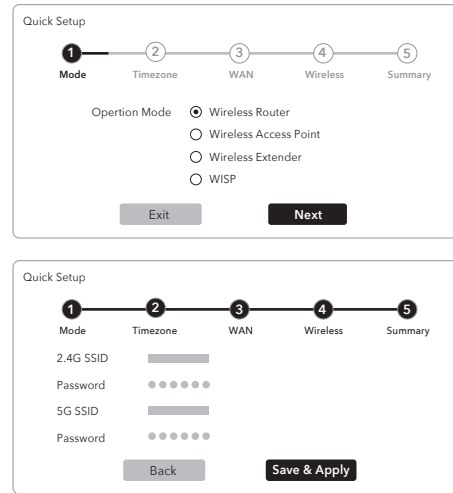

Enjoy the internet!

LED

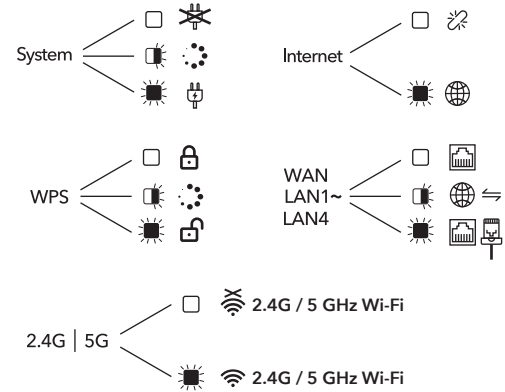

Scan the QR Code to download the Cudy App



EU Declaration of Conformity

1. English:

Cudy hereby declares that the device is in compliance with the essential requirements and other relevant provisions of directive 2014/53/EU, directive 2011/65/EU, directive (EU) 2015/863. The original EU declaration of conformity can be found at <http://www.cudy.com/ce>.

2. Deutsch:

Cudy erklärt hiermit, dass das Gerät den grundlegenden Anforderungen und anderen relevanten Bestimmungen der Richtlinie 2014/53/EU, der Richtlinie 2011/65/EU und der Richtlinie (EU) 2015/863 entspricht. Die originale EU-Konformitätserklärung finden Sie unter <http://www.cudy.com/ce>.

3. Español:

Por la presente, Cudy declara que el dispositivo cumple los requisitos esenciales y otras disposiciones pertinentes de la directiva 2014/53/UE, la directiva 2011/65/UE, la directiva (UE) 2015/863. La declaración de conformidad original de la UE se puede encontrar en <http://www.cudy.com/ce>.

4. Italiano:

Cudy dichiara che il dispositivo è conforme ai requisiti essenziali e alle altre disposizioni pertinenti della direttiva 2014/53/UE, della direttiva 2011/65/UE e della direttiva (UE) 2015/863. La dichiarazione di conformità originale dell'UE è disponibile all'indirizzo <http://www.cudy.com/ce>.

5. Français:

Cudy déclare par la présente que le dispositif est conforme aux exigences essentielles et aux autres dispositions pertinentes de la directive 2014/53/UE, de la directive 2011/65/UE, de la directive (UE) 2015/863. La déclaration de conformité originale de l'UE peut être consultée à l'adresse suivante <http://www.cudy.com/ce>.

6.Ελληνικό:

Η Cudy δηλώνει ότι η συσκευή συμμορφώνεται με τις βασικές απαιτήσεις και άλλες σχετικές διατάξεις της οδηγίας 2014/53/ΕΕ, της οδηγίας 2011/65/ΕΕ, της οδηγίας (ΕΕ) 2015/863. Η αρχική δήλωση συμμόρφωσης ΕΕ βρίσκεται στη διεύθυνση <http://www.cudy.com/ce>.

7. Dutch:

Cudy verklaart hierbij dat het apparaat voldoet aan de essentiële eisen en andere relevante bepalingen van Richtlijn 2014/53/EU, Richtlijn 2011/65/EU, Richtlijn (EU) 2015/863. De originele EU-conformiteitsverklaring is te vinden op <http://www.cudy.com/ce>.

8. Português:

Cudy declara que o dispositivo está em conformidade com os requisitos essenciais e outras disposições relevantes da Diretiva 2014/53/UE, diretiva 2011/65/UE, diretiva (UE) 2015/863. A declaração original de conformidade da UE pode ser encontrada em <http://www.cudy.com/ce>.

9. Polski:

Cudy niniejszym oświadcza, że wyrób jest zgodny z zasadniczymi wymaganiami i innymi odpowiednimi przepisami dyrektywy 2014/53/UE, dyrektywy 2011/65/UE, dyrektywy (UE) 2015/863. Oryginalną deklarację zgodności UE można znaleźć na stronie <http://www.cudy.com/ce>.

10. Türkçe:

Cudy, cihazın 2014/53/EU sayılı direktif, 2011/65/EU sayılı direktif, (EU) 2015/863 sayılı direktifin temel gerekliliklerine ve diğer ilgili hükümlerine uygun olduğunu beyan eder. Orijinal AB uygunluk beyanı şu adreste bulunabilir: <http://www.cudy.com/ce>.

11. Norsk:

Cudy erklærer herved at enheten er i samsvar med de grunnleggende kravene og andre relevante bestemmelser i direktiv 2014/53/EU, direktiv 2011/65/EU, direktiv (EU) 2015/863. Den opprinnelige EU-samsvarserklæringen finner du på <http://www.cudy.com/ce>.

12. Dansk:

Cudy erklærer hermed, at udstyret er i overensstemmelse med de væsentlige krav og andre relevante bestemmelser i direktiv 2014/53/EU, direktiv 2011/65/EU, direktiv (EU) 2015/863. Den originale EU-overensstemmelseerklæring findes på <http://www.cudy.com/ce>.

13. Suomen Kieli:

Cudy vakuuttaa täten, että laite on direktiivin 2014/53/EU, direktiivin 2011/65/EU ja direktiivin (EU) 2015/863 olennaisten vaatimusten ja muiden asiaankuuluvien säännösten mukainen. Alkuperäinen EU-vaatimustenmukaisuusvakuutus löytyy osoitteesta <http://www.cudy.com/ce>.

14. Svenska:

Cudy förklarar härmed att enheten överensstämmer med de väsentliga kraven och andra relevanta bestämmelser i direktiv 2014/53/EU, direktiv 2011/65/EU, direktiv (EU) 2015/863. Den ursprungliga EU-försäkran om överensstämmelse finns på <http://www.cudy.com/ce>.

15. Čeština:

Cudy tímto prohlašuje, že prostředek je v souladu se základními požadavky a dalšími příslušnými ustanoveními směrnice 2014/53/EU, směrnice 2011/65/EU, směrnice (EU) 2015/863. Originál EU prohlášení o shodě je k dispozici na adrese <http://www.cudy.com/ce>.

16. Slovenčina:

Cudy týmto vyhlasuje, že zariadenie je v súlade so základnými požiadavkami a ďalšími príslušnými ustanoveniami smernice 2014/53/EU, smernice 2011/65/EU a smernice (EÚ) 2015/863. Originál EÚ vyhlásenia o zhode možno nájsť na adrese <http://www.cudy.com/ce>.

17. Hungarian language:

Cudy ezúton kijelenti, hogy a készülék megfelel a 2014/53/EU irányelv, a 2011/65/EU irányelv és az (EU) 2015/863 irányelv alapvető követelményeinek és egyéb vonatkozó rendelkezésének. Az eredeti EU-megfelelősségi nyilatkozat a következő címen érhető el <http://www.cudy.com/ce>.

18. limba română:

Cudy declară prin prezenta că dispozitivul este în conformitate cu cerințele esențiale și cu alte dispoziții relevante ale Directivei 2014/53/UE, ale Directivei 2011/65/UE, ale Directivei (UE) 2015/863. Declarația de conformitate originală a UE poate fi găsită la adresa <http://www.cudy.com/ce>.

19. Български език:

С настоящото Cudy декларира, че устройството е в съответствие със съществените изисквания и други съответни разпоредби на Директива 2014/53/ЕС, Директива 2011/65/ЕС, Директива (ЕС) 2015/863. Оригинален на ЕС декларацията за съответствие може да бъде намерен на адрес <http://www.cudy.com/ce>.

20. lietuvių kalba:

"Cudy" pareiškia, kad prietaisas atitinka esminius reikalavimus ir kitas susijusias Direktyvos 2014/53/ES, Direktyvos 2011/65/ES, Direktyvos (ES) 2015/863 nuostatas. ES atitikties deklaracijos originalą galima rasti adresu <http://www.cudy.com/ce>.

21. Українська мова:

Цим Cudy заявляє, що пристрій відповідає основним вимогам та іншим відповідним положенням директиви 2014/53/ЄС, директиви 2011/65/ЄС, директиви (ЄС) 2015/863. Оригінал декларації про відповідність ЄС можна знайти за посиланням <http://www.cudy.com/ce>.

22. Hrvatski:

Cudy ovime izjavljuje da je proizvod u skladu s bitnim zahtjevima i drugim relevantnim odredbama Direktive 2014/53/EU, Direktive 2011/65/EU, Direktive (EU) 2015/863. Izvorna izjava EU-a o skladnosti može se naći na <http://www.cudy.com/ce>.

23. Slovenski jezik:

Podjetje Cudy izjavlja, da je pripomoček skladen z bistvenimi zahtevami in drugimi ustreznimi določbami Direktive 2014/53/EU, Direktive 2011/65/EU in Direktive (EU) 2015/863. Izvorna izjava EU o skladnosti je na voljo na <http://www.cudy.com/ce>.

24. latviešu valoda:

Ar šo Cudy paziņo, ka ierīce atbilst būtiskajām prasībām un citiem attiecīgajiem direktīvas 2014/53/ES, direktīvas 2011/65/ES, direktīvas (ES) 2015/863 un direktīvas (ES) 2015/863 noteikumiem. ES atbilstības deklarācijas oriģināls ir atrodamas vietnē <http://www.cudy.com/ce>.

25. Eesti keel:

Cudy deklareerib käesolevaga, et seade vastab olulistele nõuetele ja muudele direktiivi 2014/53/EU, direktiivi 2011/65/EU ja direktiivi (EÜ) 2015/863 asjakohastele sätetele. EU vastavusdeklaratsiooni originaal on kätesaadav aadressil <http://www.cudy.com/ce>.

WEEE

According to the EU Directive on Waste Electrical and Electronic Equipment (WEEE - 2012/19 / EU), this product must not be disposed of as normal household waste. Instead, they should be returned to the place of purchase or taken to a public collection point for recyclable waste. By ensuring this product is disposed of correctly, you will help prevent potential negative consequences for the environment and human health, which could otherwise be caused by inappropriate waste handling of this product. For more information, please contact your local authority or the nearest collection point. Improper disposal of this type of waste may result in penalties according to national regulations.

GNU General Public License Notice

The software code in this product was created by third parties and is licensed under the GNU General Public License ("GPL"). If applicable, Cudy ("Cudy" in this context refers to the Cudy entity offering respective software for download or being in charge of the distribution of products that contain respective code) makes the corresponding GPL source code available upon request via the official website, either independently or with the assistance of third parties (such as Shenzhen Cudy Technology Co., Ltd.).

For GPL-related questions, email support@cudy.com. In addition, Cudy offers a GPL Code-Centre under <https://www.cudy.com/gplcodecenterdownload> where users can get the GPL source codes used in Cudy products for free. Please note, that the GPL Code-Centre is only provided as a courtesy to Cudy's customers but may neither offer a full set of source codes used in all products nor always provide the latest or actual version of such source codes. The GPL code used in this product is subject to the copyrights of one or more authors and is supplied WITHOUT ANY WARRANTY.

